

FITTING INSTRUCTION

Clamp mark in acc. with		Cables joining
ISO	PN	
1	L	Left directional lights
2	+	Rear fog lights
3	31	Ground
4	R	Right directional lights
5	58R	Right side parking lights
6	54	Stoplights
7	58L	Left side parking lights

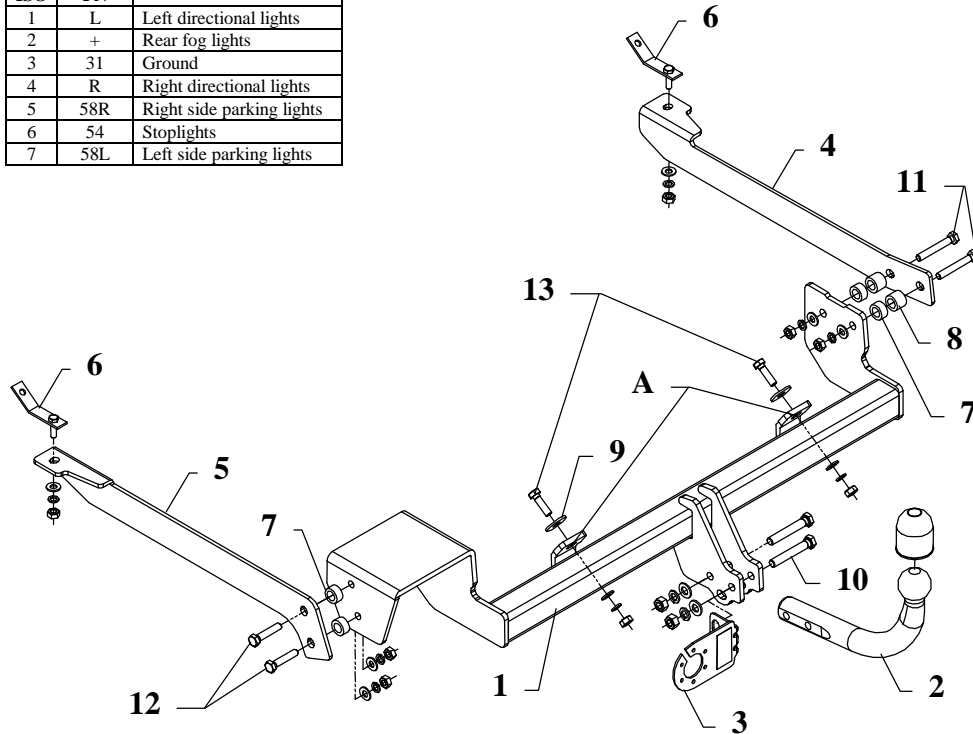

This towing hitch is designed to assembly in following cars:
CITROEN XSARA ESTATE, produced since 1998 till 2005, catalogue no. **P14** and is prepared to tow trailers max total weight **1300 kg** and max vertical load **80 kg**.

From manufacturer

Thank you for buying our product. Their reliability has been confirmed in many tests. Reliability of towing hitch depends also on correct assembly and right operation. For this reasons we kindly ask to read carefully this instruction and apply to hints.

The towing hitch should be install in points described by a car producer.

The instruction of the assembly

1. Take the spare wheel and fitted carpet out the boot.
2. Reveal the holes on the left and right side in the boot (they are cover with plastic ellipse plugs) and then position jib with the bolts M10 (pos. 6) through these holes.
3. Position the main bar of the towing hitch (pos. 1) to the rear panel and fix it through the towing hitch holes (pos. A) using bolts M10x35mm (pos. 13) and washers (pos. 9). Fix it loosely.
4. Slide the bracket (pos. 5) outside the left chassis member and fix it together with sleeves 25x16, L=12mm (pos. 7) using bolts M10x50mm – pos. 12 (see the drawing).
5. Slide the bracket (pos. 4) outside the right chassis member and fix it together with two sleeves 25x16, L=19mm (pos. 8) and two sleeves 25x16, L=12mm (pos. 7) using bolts M10x70mm – pos. 11 (see the drawing).
6. The brackets (pos. 4 and 5) fix with jib with the bolts M10 (pos. 6).
7. Position the tow-ball (pos. 2) with the socket plate (pos. 3) and fix it with M12x75mm (pos. 10) bolts from the towing hitch accessories.
8. Tighten all nuts and bolts according to the torque shown in the table.
9. Connect the electric wires according to the instructions of the car.
10. Complete the paint cover of towing hitch (during the mounting paint cover could be destroyed).

Torque settings for nuts and bolts (8,8):	
M 8 - 25 Nm	M 10 - 55 Nm
M 12 - 85 Nm	M 14 - 135 Nm

NOTE

After install the towing hitch you should get adequate note in registration book (at authorised service station).The car should be equipped with:

- Indicators
- Tow mirrors

After 1000km of exploitation check all bolts and nuts. The ball of towing hitch must be always kept clear and conserve with a grease.

Towing hitch accessories:

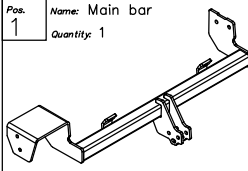
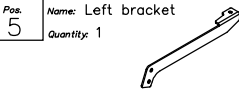
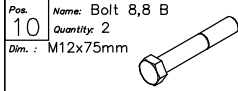
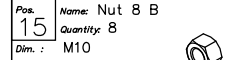
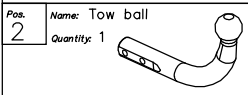
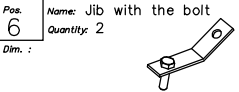
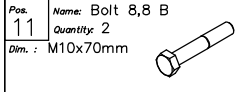
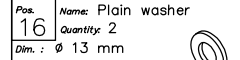
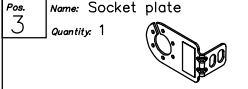
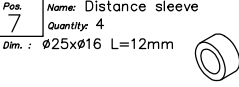
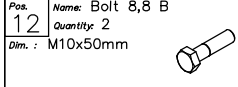
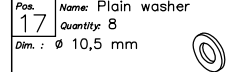
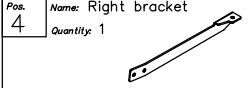
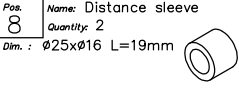
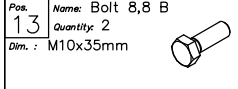
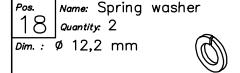
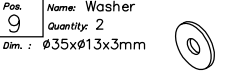
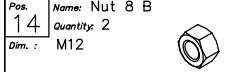
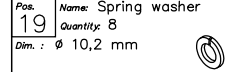
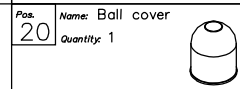
Pos. 1 Name: Main bar Quantity: 1 	Pos. 5 Name: Left bracket Quantity: 1 	Pos. 10 Name: Bolt 8,8 B Quantity: 2 Dim.: M12x75mm 	Pos. 15 Name: Nut 8 B Quantity: 8 Dim.: M10 
Pos. 2 Name: Tow ball Quantity: 1 	Pos. 6 Name: Jib with the bolt Quantity: 2 Dim.: 	Pos. 11 Name: Bolt 8,8 B Quantity: 2 Dim.: M10x70mm 	Pos. 16 Name: Plain washer Quantity: 2 Dim.: Ø 13 mm 
Pos. 3 Name: Socket plate Quantity: 1 	Pos. 7 Name: Distance sleeve Quantity: 4 Dim.: Ø25xØ16 L=12mm 	Pos. 12 Name: Bolt 8,8 B Quantity: 2 Dim.: M10x50mm 	Pos. 17 Name: Plain washer Quantity: 8 Dim.: Ø 10,5 mm 
Pos. 4 Name: Right bracket Quantity: 1 	Pos. 8 Name: Distance sleeve Quantity: 2 Dim.: Ø25xØ16 L=19mm 	Pos. 13 Name: Bolt 8,8 B Quantity: 2 Dim.: M10x35mm 	Pos. 18 Name: Spring washer Quantity: 2 Dim.: Ø 12,2 mm 
	Pos. 9 Name: Washer Quantity: 2 Dim.: Ø35xØ13x3mm 	Pos. 14 Name: Nut 8 B Quantity: 2 Dim.: M12 	Pos. 19 Name: Spring washer Quantity: 8 Dim.: Ø 10,2 mm 
			Pos. 20 Name: Ball cover Quantity: 1 



PPUH AUTO-HAK S.J.

Produkcja Zaczepów Kulowych
Henryk & Zbigniew Nejman
76-200 SŁUPSK ul. Słoneczna 16K
tel/fax (059) 8-414-414; 8-414-413
E-mail: office@autohak.com.pl
www.autohak.com.pl

Towing hitch (without electrical set)

Class: **A50-X** Cat. no. **P14**

Designed for:

Manufacturer: **CITROEN**

Model: **XSARA**

Type: **ESTATE**

produced since 1998 till 2005

Technical data:

D-value: 7,21 kN

maximum trailer weight: **1300 kg**

maximum vertical cup load: **80 kg**

Approval number acc. to regulations EKG/ONZ 55.01: **E20-55R-01 0855**

Foreword

This towing hitch is designed according to rules of safety traffic regulations. The towing hitch is a safety component and can be install only by qualified personnel. Any alteration or conversion of the towing hitch is prohibited and would lead to cancellation of design certification. Remove insulating compound and underseal from vehicle (if present) in the area of the matting surfaces of the towing hitch. The vehicle manufacturer's specifications regarding trailer load and max. vertical cup load are decisive for driving, and values for the towing hitch cannot be exceeded.

D-value formula:

$$\frac{\text{Max trailer weight [kg]} \times \text{Max vehicle weight [kg]}}{\text{Max trailer weight [kg]} + \text{Max vehicle weight [kg]}} \times \frac{9,81}{1000} = D \text{ [kN]}$$